

SONICWARE

LIVEN

8bit warps

User's Manual



FCC regulation warning (for USA)

Note: This equipment has been tested and found to comply with the limits for a Class B digital device, pursuant to part 15 of the FCC Rules. These limits are designed to provide reasonable protection against harmful interference in a residential installation. This equipment generates, uses and can radiate radio frequency energy and, if not installed and used in accordance with the instructions, may cause harmful interference to radio communications. However, there is no guarantee that interference will not occur in a particular installation. If this equipment does cause harmful interference to radio or television reception, which can be determined by turning the equipment off and on, the user is encouraged to try to correct the interference by one or more of the following measures:

- Reorient or relocate the receiving antenna.
- Increase the separation between the equipment and receiver.
- Connect the equipment into an outlet on a circuit different from that to which the receiver is connected.
- Consult the dealer or an experienced radio/TV technician for help.

Legal disclaimers

Sonicware Inc. (hereafter, "SONICWARE" strives to assure that this document is as accurate and current as possible, but will bear no responsibility for any compensation, claims or losses due to content included in this document. Moreover, information in this document could be changed without notice. SONICWARE retains the right to change product specifications and programs at any time. SONICWARE will bear no responsibility for any errors depicted in this document. SONICWARE will bear no responsibility for any losses resulting from the use of this information, functions or performance, regardless of contracts, lack of caution or other conduct.

Copyrights and registered trademarks

- SONICWARE is a registered trademark of Sonicware Inc.
- MIDI is a registered trademark of the Association of Musical Electronics Industry (AMEI).
- Other company names, product names, standard names and registered trademarks in this document are the property of their respective owners.
- All the trademarks and registered trademarks in this document are not intended to violate the copyrights of their owners, but rather are included for the purpose of identification only.
- Recording from copyrighted sources, including audio files, CDs, records, videos, tapes, broadcasts, streamed content and works of art, without permission of the copyright holder for any purpose other than personal use is prohibited by law.
- Sonicware Inc. will not assume any responsibility related to infringements of copyrights.

Important safety precautions

You must read the following precautions in order to use the product safely and prevent accidents.

WARNING: Failure to follow these precautions could result in serious harm to the user or even death.

- Operation using an AC adapter
Do not do anything that could exceed the ratings of outlets and other electrical wiring equipment.
Disconnect the AC adapter with USB output from the outlet when lightning occurs and when not using it for a long time.
- Operation using batteries
Use-commercially available 1.5V AA batteries.
Carefully read the precautions of the batteries being used.

Be sure to insert the batteries with +/ – ends oriented correctly.

Do not use new and old batteries together. Do not use batteries of different types together.

Remove the batteries when they will not be used for a long time.

If a leak occurs, thoroughly wipe the battery compartment and battery terminals to remove the leaked fluid.

- Do not open the case and disassemble or modify the product.
- Do not drop, strike or apply excessive force to the unit.
- Did not put liquid on or in the unit.
- Do not put foreign objects into the case.
- Do not use at a loud volume. Doing so could generate loud volumes that might lead to hearing loss.
- When transferring this unit, use the individual packing box and cushioning material that it came with when purchased new.
- When the unit is powered on, do not wrap it in cloth, plastic or other materials.
- Do not step on or apply pressure to the power cord.
- Do not use in the following environmental conditions. Doing so could cause malfunction.

Locations in direct sunlight, environments that exceed 40°C, or near stoves and other heat sources

Locations with extremely low or high temperatures

Locations with extremely high humidity or where the product could become wet

Locations with frequent vibrations or much dust or sand

- If the unit becomes broken or malfunctions, immediately turn the power off and stop using it.

Usage Precautions

Failure to follow these precautions could cause injury to the user and physical damage.

- When connecting cables or working with the power of the unit, minimize the input levels of connected devices or turn them off.
- Cleaning
 - If the screen or the case become dirty, wipe them gently with a soft cloth.
 - Do not use chemicals, including alcohol, benzene, thinner or cleansers.
 - If this does not clean them, wipe them with a slightly damp cloth that has been wrung out well.
 - Do not turn the power on until the product is completely dry.

Contents

Preparing to play	5	Synchronizing the tempo with an external device connected to the SYNC IN	16
Names of parts	5	Synchronizing tempo with an ELZ_1 or Pocket Operator (PO)	17
Connecting	5	Step sequencer and rhythm settings	18
Preparing for startup	6	Changing the sequencer mode	18
Starting up	6	Overwriting steps while recording (overwrite mode)	18
Turning the unit off	6	Changing the sequencer and arpeggiator gate time	18
Patch memories and patterns	6	Changing the sequencer swing	18
Basic operations	7	Changing the tempo	18
Adjusting the overall volume	7	Changing keys (transposing)	18
Changing the octave range	7	Changing the note of a single step	19
Basic knob operation	7	Changing the pattern length	19
Changing patch memories and playing	7	Setting a pre-count	19
Adjusting the note velocity	7	Looper playback and recording	20
Sweeping notes while playing	7	Enabling looper mode	20
Holding the keyboard	7	New recording to looper tracks	20
Adjusting the sound	8	Overwrite recording to looper tracks	20
Initializing patch memories	8	Continuous recording to looper tracks	20
Saving patch memories	8	Recording without the sequencer	20
Reloading patch memories	8	Playing and stopping looper tracks	20
Changing the synth engine	8	Playing and stopping loopers and patterns at once	21
Adjusting synth engines	8	Erasing looper tracks	21
Adjusting the amount of detuning	8	Adjusting the looper	22
Turning aliasing noise on/off	8	Adjusting looper track levels	22
Turning the filter on/off	9	Adjusting the level of looper track 4 and the external input	22
Changing the filter type	9	Adjusting looper track panning	22
Changing the filter cutoff frequency	9	Changing looper quantization	22
Adjusting the filter resonance	9	Changing looper length	22
Adjusting the LFO speed	9	External input settings	23
Adjusting the amount of LFO effect on pitch	9	Changing the gain	23
Adjusting the amount of LFO effect on filter cutoff	9	Changing the reverb send amount	23
Adjusting the envelope generator	9	Setting mono/stereo	23
Changing the effect type	10	MIDI settings	24
Changing effect parameters	10	Setting the receiving channel	24
Changing the reverb type	10	Setting the transmitting channel	24
Changing reverb parameters	10	Turning control change transmission on/off	24
Changing the sweep speed	10	Turning program change transmission on/off	24
Changing the sweep shift amount	10	Turning MIDI clock output on/off	24
Changing the voice mode	11	Setting MIDI OUT	24
Changing the legato speed	11	Setting MIDI command	24
Changing the arpeggiator type	11	Saving and loading user data	25
Changing patch memory levels	11	Exporting patch memories	25
Creating and editing waveforms	12	Exporting patterns	25
Editing waveforms (easy mode)	12	Exporting patch memories and patterns	25
Automatically advancing to the next sample during waveform editing (waveform editing auto step)	12	Importing patch memory and pattern data	25
Editing waveforms (advanced mode)	12	Exporting waveform data	25
Clearing waveforms	13	Importing waveform data	25
Loading waveforms	13	Backing up user data	26
Loading synth engine waveforms(capture mode)	13	Restoring user data	26
Step sequencer playback and recording	14	System settings	27
Pattern playback	14	Enabling the function setting state	27
Selecting patterns	14	Setting the automatic power off function	27
Selecting multiple patterns and playing them back in order (chain playback)	14	Setting the battery type	27
Initializing patterns	14	Setting the master tuning	27
Step recording	15	Setting the clock source	27
Recording in real time	15	Setting the polarity of SYNC IN	27
Directly inputting notes on steps	15	Setting the polarity of SYNC OUT	27
Saving patterns	16	Setting knob movement function	28
Reloading patterns	16	Adjusting the metronome volume	28
Recording parameter operations (parameter locking)	16	Enabling/disabling speaker output	28
Recording parameter operations in real time	16	Setting the headphone gain	28
Turning parameter locking on/off	16	Checking the system version	28
Initializing parameter locks	16	Restoring to factory default settings (factory reset)	28
Clearing note and parameter data	16	Appendix	29

Preparing to play

Names of parts

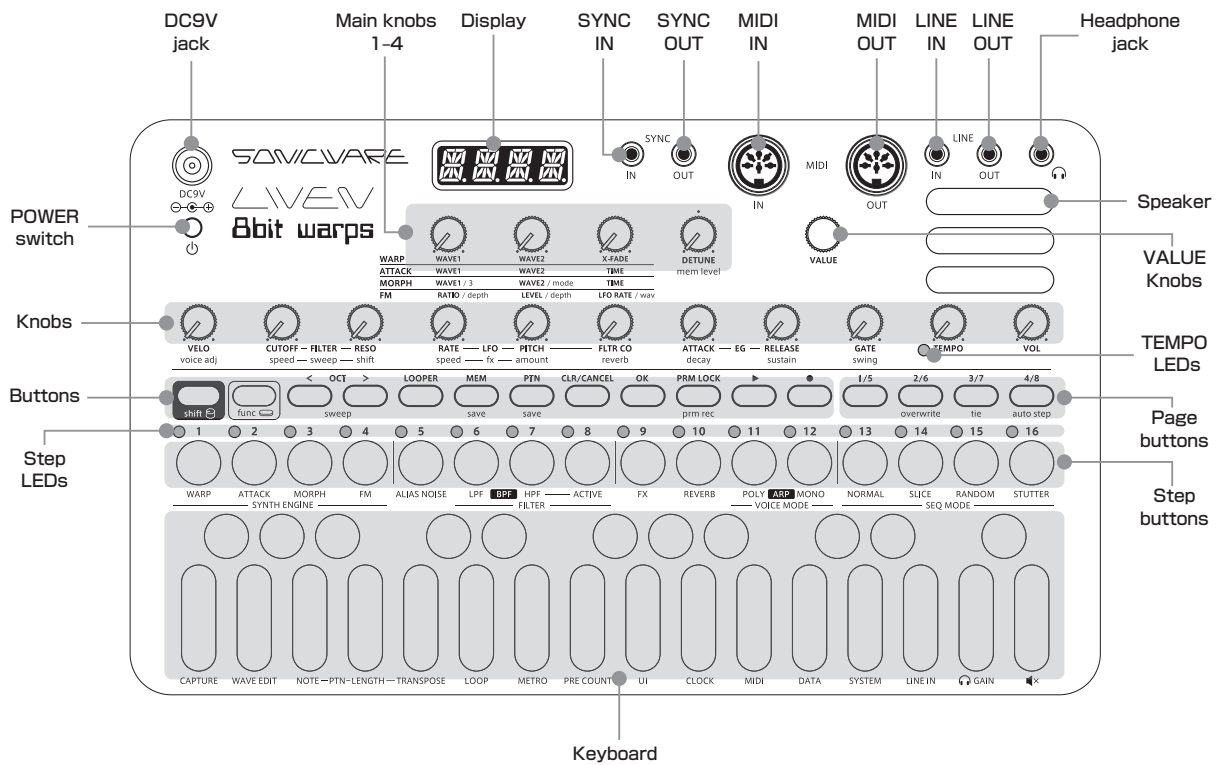

Connecting

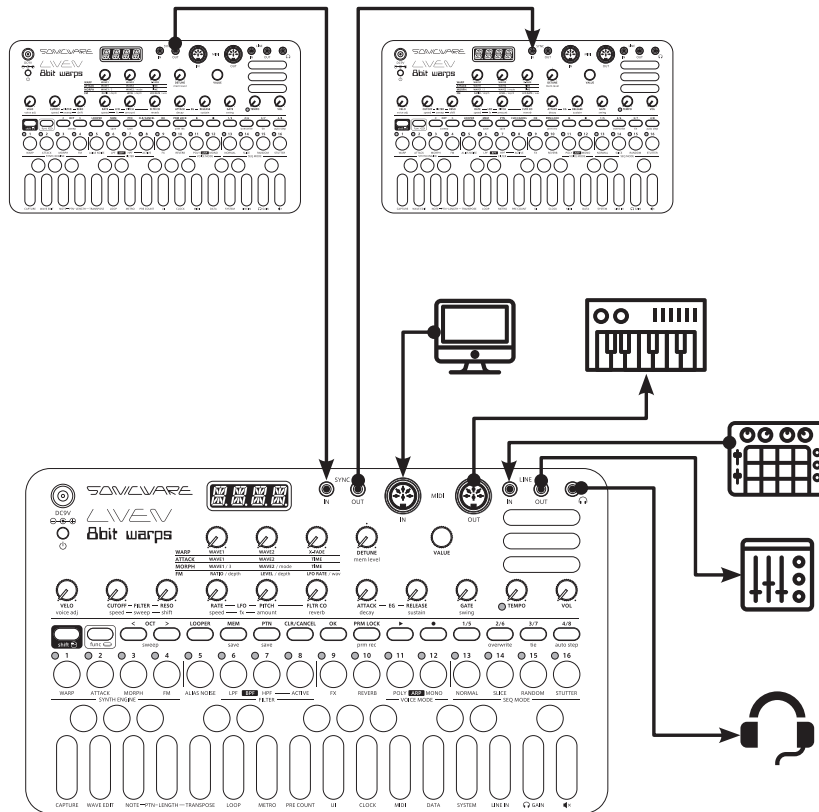

Note : Use connection cables that are 3 m or shorter.

Preparing to play

Preparing for startup

- ① Connect a specified AC adapter(9V output, 1A or more, EIAJ3, inner diameter 1.7mm, outer diameter 4.75mm, center +) to the LIVEN 8bit warps DC9V jack.
- ② Plug the AC adapter into an outlet.



- To power the LIVEN 8bit warps using batteries, open the cover on the bottom and install 6 AA batteries.
- When the remaining battery charge becomes low, BT.LO will appear on the display at regular intervals. (The BT.LO display interval will become shorter according to the remaining charge.)
- BT.LO will appear on the display when starting up if the remaining battery charge is low.



- When BT.LO appears, replace the batteries right away.

Starting up

- ① Press and hold the POWER switch to turn on the LIVEN 8bit warps.

Turning the unit off

- ① Press and hold the POWER switch to turn off the LIVEN 8bit warps.



- Sound settings that have been edited will be lost when the power is turned off, so save them as necessary beforehand.

Patch memories and patterns

Patch memories are units that save settings related to sounds, including synth engine parameter data.

Patterns are units that save performance data.

Up to 128 patch memories and 128 patterns can be saved in this unit.

When shipped new from the factory, preset sounds and sequences are saved in some patch memories and patterns.



- Preset patches : M001-M064
- User patches : M065-M128

- Preset patterns : P001-P064
- User patterns : P065-P128

Patch memories and patterns are saved in separate areas, but a single patch memory can be linked to a pattern. With this linking, loading a pattern will automatically load the linked patch memory



- When a pattern is saved, the linked patch memory will not be saved automatically. Only the number of the linked patch memory is saved inside the pattern.
- If the sound has been edited, save the patch memory (see "Saving patch memories").
- If a parameter being shown matches the original, a dot will appear at the bottom right of the display.
- Relationship between patch memories and patterns

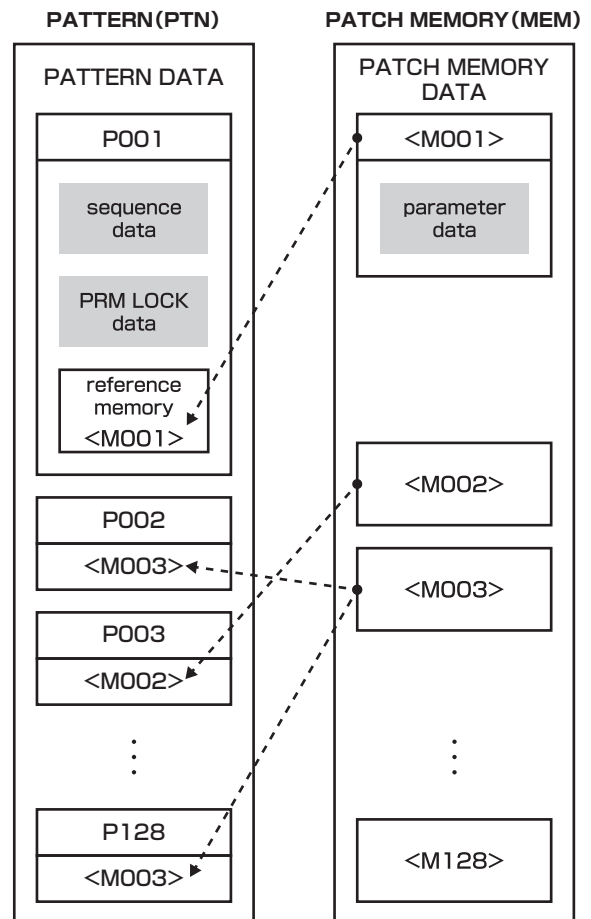

Basic operations

This section explains basic operations.

Adjusting the overall volume

- ① Turn the **VOL** knob.



- The levels are shown on the display.
- They can be adjusted from $-\infty$ to +6 dB with 0 dB as the middle values (63-64).
- The adjustment range is 0-127.

Changing the octave range

- ① Press **oct**< to lower the octave and **oct**> to raise the octave.



- The octave can be raised or lowered by ± 3 from the standard octave.
- Depending on the octave, the octave button colors change from green (± 1) to orange (± 2) to red (± 3). (They are unlit when the octave has not been changed.)

Basic knob operation

Turning a knob will change the parameter printed in uppercase letters.

Turning a knob while pressing **shift** will change the parameter printed in lowercase letters.



- While pressing **func**, press **shift** to hold **shift**. (Press **shift** to return to the normal state.)

Changing patch memories and playing

- ① Press **MEM** to light the step LED for the currently selected patch memory.
- ② Press **1/5**, **2/6**, **3/7** or **4/8** to select the patch memory range.



- The patch memory ranges correspond to page buttons as follows.

Patch memories 1-16 : **1/5** lit green

Patch memories 17-32 : **2/6** lit green

Patch memories 33-48 : **3/7** lit green

Patch memories 49-64 : **4/8** lit green

Patch memories 65-80 : **1/5** lit orange

Patch memories 81-96 : **2/6** lit orange

Patch memories 97-112 : **3/7** lit orange

Patch memories 113-128 : **4/8** lit orange

- ③ Press a step button to select a patch memory.



- The patch number is shown on the display.
- The **VALUE** knob can also be turned to select patch memories.
- In step ①, press **MEM** twice to light **MEM** orange and enable continuous selection of patch memories.



- In patch memory selection mode, the following functions behave as normal.

1. All knobs (except VALUE)
2. All LEDs (except Page buttons)
3. The keyboard

Adjusting the note velocity

- ① Turn the **VELO** knob.



- The parameter is shown on the display.
- The adjustment range is 0-127.

Sweeping notes while playing

- ① While pressing **func** (lit green), press **oct/sweep**< (sweep down) or **oct/sweep**> (sweep up).



- Press again to end (**oct/sweep**< and **oct/sweep**> become unlit).
- Patterns recorded with sweep active will also sweep during pattern playback.

Holding the keyboard

- ① While pressing **OK**, play the keyboard to hold keyboard.



- Play the same keyboard to return to the normal state.
- While pressing **CLR/CANCEL**, press **OK** to release the hold on all keyboards.

Adjusting the sound

This section explains how to adjust the sound, including the synth engine, filter, LFO, envelope generator (EG) and effects.

Initializing patch memories

- ① While pressing CLR/CANCEL, press MEM.



- CLR will appear on the display.

Saving patch memories

- ① While pressing func, press MEM to light it red.
The page button and the LED that correspond to the selected patch memory light.



- The patch memory ranges correspond to page buttons as follows.

Patch memories 1-16 : 1/5 lit green

Patch memories 17-32 : 2/6 lit green

Patch memories 33-48 : 3/7 lit green

Patch memories 49-64 : 4/8 lit green

Patch memories 65-80 : 1/5 lit orange

Patch memories 81-96 : 2/6 lit orange

Patch memories 97-112 : 3/7 lit orange

Patch memories 113-128 : 4/8 lit orange

- ② Use 1/5, 2/6, 3/7 or 4/8 to select the destination patch memory range, and press the step button for the desired number to save it.



- DONE will appear on the display.
- This can also be saved by turning the VALUE knob and pressing OK.
- See the preset patch list for details about the preset patches. (See attachment)
- After changing a sound, the changes will be lost if the patch memory is not saved.
- Press CLR/CANCEL to cancel saving.

Reloading patch memories

- ① Press MEM.

The page button that corresponds to the selected patch memory lights green or orange, and the LED that corresponds lights.

- ② Press OK or the step key that corresponds to the

selected patch memory.



- When a patch memory is reloaded, the sound is restored to its last saved state.

Changing the synth engine

- ① Press and hold func to light the LED for the current SYNTH ENGINE.
- ② Press any SYNTH ENGINE button.



- The synth engine name appears on the display.
- 4 types of synth engines can be chosen.
 1. WARP : This synth crossfades between two waveforms.
 2. ATTACK (ATK on display) : This synth switches waveforms when the set amount of time passes after a key is played.
 3. MORPH (MRPH on display) : This synth morphs through three waveforms in order.
 4. FM : This 8-bit waveform memory synth is like an FM sound source.

Adjusting synth engines

- ① Turn Main knobs 1-3. (See P26.)



- The parameter is shown on the display.
- Turn these knobs while pressing and holding shift to adjust other synth engine parameters.
- See the preset waveform list for the preset waveforms. (See attachment).

Adjusting the amount of detuning

- ① Turn Main knob 4 (DETUNE/mem level).



- The detune amount is shown on the display.
- The adjustment range is -16 - +16.

Turning aliasing noise on/off

- ① While pressing func, press ALIAS NOISE.
Depending on the aliasing noise on/off status, the ALIAS NOISE LED is lit/unlit.

Adjusting the sound



- ON or OFF will appear on the display.

Turning the filter on/off

- ① While pressing func , press ACTIVE .

Depending on the on/off status, the ACTIVE LED is lit/unlit.



- The filter type/OFF is shown on the display.

Changing the filter type

- ① While pressing func , press a FILTER button.
The LED will light for the selected filter type.
(For BPF, both LPF and HPF LEDs will light red.)



- To select BPF, press LPF and HPF at the same time.
- The filter type name is shown on the display.
- Three types of filters can be selected.
 1. LPF : Filter that cuts high frequencies
 2. HPF : Filter that cuts low frequencies
 3. BPF : Filter that only allows through frequencies in the specified band

Changing the filter cutoff frequency

- ① Turn the CUTOFF/speed knob.



- The parameter is shown on the display.
- The adjustment range is 0-127.
- The frequency can be changed in a range of 70-21600Hz.

Adjusting the filter resonance

- ① Turn the RESO/shift knob.



- The parameter is shown on the display.
- For BPF, this adjusts the width of the band.
- The adjustment range is 0-127.
- The resonance can be changed in a range of 0.1-10.
- For BPF, the bandwidth can be changed in a 0.1-2.0 octave range.

Adjusting the LFO speed

- ① Turn the RATE/speed knob.



- The parameter is shown on the display.
- The LFO produces a sine wave.
- The adjustment range is 0-127.
- The frequency can be changed in a range of 0.1-30 Hz.

Adjusting the amount of LFO effect on pitch

- ① Turn the PITCH/amount knob.



- The parameter is shown on the display.
- The adjustment range is 0-127.
- This changes it in a range of 0-2 octaves.

Adjusting the amount of LFO effect on filter cutoff

- ① Turn the FLTR CO/reverb knob.



- The parameter is shown on the display.
- The adjustment range is 0-127.

Adjusting the envelope generator

- ① Turn the ATTACK/decay and RELEASE/sustain knobs.



- The parameter is shown on the display.
- To change the decay and sustain, turn the ATTACK/decay and RELEASE/sustain knobs while pressing and holding shift .
- The adjustment range is 0-127.
- ATTACK, decay and RELEASE can be set in time ranges of 0-5000 ms.
- The level set by sustain is 0-100%.

Adjusting the sound

Changing the effect type

- ① While pressing func , press FX to select the effect.
The FX button lights when the effect is not off.



- The effect type name is shown on the display.
- 5 types of effects can be chosen.
 1. OFF
 2. CHORUS (CHRS on display)
 3. FLANGER (FLNG on display)
 4. DELAY (DLY on display)
 5. CRUSH (CRSH on display)

Changing effect parameters

- ① While pressing shift , turn the RATE/speed and PITCH/amount knobs.



- The parameter is shown on the display.
- The speed parameter changes the effect time, and the amount parameter changes the strength of the effect.
- The adjustment range is 0-127.

Changing the reverb type

- ① While pressing func , press REVERB to select the reverb.
The REVERB button lights when the reverb is not off.



- The reverb type name is shown on the display.
- 8 reverb types can be chosen.
 1. OFF
 2. HALL
 3. ROOM
 4. ARENA (ARNA on display)
 5. PLAT (PLAT on display)
 6. TUNNEL (TNNL on display)
 7. INFINITY (INF on display)
 8. TAPE

Changing reverb parameters

- ① While pressing shift , turn the FLTR CO/reverb knob.



- The parameter is shown on the display.
- The adjustment range is 0-127.



- This adjusts the reverb mix amount and direct sound.
- In TAPE, this adjusts the noise mix and wow flutter amount.

Changing the sweep speed

- ① While pressing shift , turn the CUTOFF/speed knob.



- The parameter is shown on the display.
- The adjustment range is 1-7.
- The time sweep takes to change one step is as follows.
 1. 7.8 ms
 2. 15.6 ms
 3. 23.4 ms
 4. 31.3 ms
 5. 39.1 ms
 6. 46.9 ms
 7. 54.7 ms

Changing the sweep shift amount



- ① While pressing shift , turn the RESO/shift knob.



- The parameter is shown on the display.
- The adjustment range is 0-7.

Adjusting the sound

Changing the voice mode

- ① While pressing , press  or  to select the voice mode.





The LED will light for the selected voice mode.

(For ARP, both  and  LEDs will light red.)



- The voice mode name is shown on the display.
- 3 voice modes can be chosen.
 1. POLY : Up to 6 voices can be output simultaneously in this mode
 2. MONO : 1 voice is output in this mode
 3. ARPEGGIATOR (ARP on display) :
Pressed keyboard keys are played one at a time in this mode





Changing the legato speed

- ① While pressing , press  and set the voice mode to MONO.
- ② While pressing , turn the  **VELO/voice adj** knob.



- The parameter is shown on the display.
- The adjustment range is 0-127.
- The time can be changed in a range of 0-10000 ms.

Changing the arpeggiator type

- ① While pressing , press  and  simultaneously to select the arpeggiator.
- ② While pressing , turn the  **VELO/voice adj** knob to select the arpeggiator type.



- The type name appears on the display
- 12 arpeggiator types can be selected.
 1. UP :
Plays notes from lowest to highest repeatedly
 2. DOWN :
Plays notes from highest to lowest repeatedly
 3. UP DOWN (UP.DN on display) :
Plays notes from lowest to highest to lowest to highest repeatedly
 4. DOWN UP (DN.UP on display) :
Plays notes from highest to lowest to highest to lowest repeatedly
 5. UP&DOWN (U.A.D on display) :

Plays notes from lowest to highest, then plays from highest to lowest repeatedly

6. DOWN&UP (D.A.U on display) :

Plays notes from highest to lowest, then plays from lowest to highest repeatedly

7. RANDOM (RAND on display) :

Plays notes in random order

8. UP+1 (UP+1 on display) :

Plays notes from lowest to highest for 2 octaves (repeating the pattern in the higher octave) repeatedly

9. UP+2 (UP+2 on display) :

Plays notes from lowest to highest for 3 octaves (repeating the pattern in the higher octaves) repeatedly

10. DOWN-1 (DN-1 on display) :

Plays notes from highest to lowest for 2 octaves (repeating the pattern in the lower octave) repeatedly



11. DOWN-2 (DN-2 on display) :

Plays notes from highest to lowest for 3 octaves (repeating the pattern in the lower octaves) repeatedly

12. PLAY ORDER (P.O on display) :

Plays notes in the order played on the keyboard

Changing patch memory levels

- ① While pressing , turn the  **Main 4** (DETUNE/mem level) knob.



- The parameter is shown on the display.
- The adjustment range is 0-127.
- It can be adjusted from $-\infty$ to +12 dB with 0 dB as the middle value.

Creating and editing waveforms

This section explains how to create and edit waveforms.

Editing waveforms (easy mode)

- ① While pressing $\overline{\text{func}}$, press $\overline{\text{WAVE EDIT}}$.

A page button and step LED light, showing the position of the selected waveform.



- EDIT will appear on the display.

- ② Turn the \ominus **VALUE** knob, and select a waveform.



- The waveform can also be selected by pressing $\overline{1/5}$ (U-01-U-16), $\overline{2/6}$ (U-17-U-32), $\overline{3/7}$ (U-33-U-48) or $\overline{4/8}$ (U-49-U-64) to select the page, and then pressing the step button.
- The waveform number (U-number) appears on the display.
- The selection range is U-01-U-64.

- ③ Press $\overline{\text{OK}}$ to enter waveform editing mode.

- ④ While pressing $\overline{\text{func}}$, press $\overline{1/5}$ to select EASY.

- ⑤ Turn the \ominus **VALUE** knob to select the sample position to edit.

Step LED 1-16 will light according to the selected sample value.



- The sample position is shown on the display.
- The sample position range is 1-32.

- ⑥ Press a step button to set the parameter.



- The step buttons show values as follows.

Step button 1 : - 128

Step button 2 : - 112

Step button 3 : - 96

Step button 4 : - 80

Step button 5 : - 64

Step button 6 : - 48

Step button 7 : - 32

Step button 8 : - 16

Step buttons 8 & 9 : 0

Step button 9 : 16

Step button 10 : 32

Step button 11 : 48

Step button 12 : 64

Step button 13 : 90

Step button 14 : 96

Step button 15 : 112

Step button 16 : 127

- If the waveform editing auto step function is enabled, pressing the step button will automatically move to the next sample position. (See "Automatically advancing to the next sample during waveform editing (waveform editing auto step)" .)

- ⑦ Repeat steps ⑤ and ⑥, and press $\overline{\text{OK}}$.

- ⑧ Turn the \ominus **VALUE** knob and select the waveform number where it will be saved.



- The waveform can also be selected by pressing $\overline{1/5}$ (U-01-U-16), $\overline{2/6}$ (U-17-U-32), $\overline{3/7}$ (U-33-U-48) or $\overline{4/8}$ (U-49-U-64) to select the page, and then pressing the step button.
- The waveform number (U-number) appears on the display.
- The selection range is U-01-U-64.

- ⑨ Press $\overline{\text{OK}}$ to save the waveform and end waveform editing mode.

Automatically advancing to the next sample during waveform editing (waveform editing auto step)

- ① Follow steps ① - ④ in "Editing waveforms (easy mode)" .

- ② Press $\overline{\text{auto step}}$.

When in easy mode, $\overline{4/8}$ lights red if auto step is enabled.



- This can only be changed when in easy waveform editing mode.

Editing waveforms (advanced mode)

- ① Follow steps ① - ③ in "Editing waveforms (easy mode)" .

- ② While pressing $\overline{\text{func}}$, press $\overline{1/5}$ to select ADV.

- ③ Press a step button to select the sample position to edit.

The LED for the selected step will light.

Creating and editing waveforms



- Use the $\frac{1}{175}$ (1-16) and $\frac{1}{276}$ (17-32) buttons to select pages.

④ Turn the \ominus **VALUE** knob to set the parameter.



- The parameter is shown on the display.
- The adjustment range is - 128 - 127.

⑤ Repeat steps ③ and ④, and press $\frac{1}{OK}$.

⑥ Turn the \ominus **VALUE** knob and select the waveform number where it will be saved.



- The waveform can also be selected by pressing $\frac{1}{175}$ (U-01-U-16), $\frac{1}{276}$ (U-17-U-32), $\frac{1}{377}$ (U-33-U-48) or $\frac{1}{478}$ (U-49-U-64) to select the page, and then pressing the step button.
- The waveform number (U-number) appears on the display.
- The selection range is U-01-U-64.

⑧ Press $\frac{1}{OK}$ to save the waveform and end waveform editing mode.

Clearing waveforms

① Follow steps ① - ④ in "Editing waveforms (easy mode)".

② While pressing $\frac{1}{func}$, press $\frac{1}{CLR/CANCEL}$.



- All waveform data for the selected waveform number will be set to 0.
- The waveform can also be edited after this.
- CLR will appear on the display.

Loading waveforms

① Follow steps ① - ④ in "Editing waveforms (easy mode)".

② While pressing $\frac{1}{func}$, press $\frac{1}{▶}$.

③ Turn the \ominus **VALUE** knob to select the number of the waveform to be loaded.



- Waveforms can also be selected by selecting a page key and pressing a step key. (Pages 1-4 are preset waveforms and pages 5-8 are user waveforms.)

- The preset waveform name or user waveform number (U-number) appears on the display.
- The selection range is preset waveforms 1-63 and U-01-U-64.

④ Press $\frac{1}{OK}$ to copy the waveform and start waveform editing mode.

Loading synth engine waveforms (capture mode)

① While pressing $\frac{1}{func}$, press $\frac{1}{CAPTURE}$.

② Turn the \ominus **VALUE** knob and select the waveform number where it will be saved.



- Capture mode can only be enabled when the synth engine is WARP or FM.
- CPTR will appear on the display.



- The waveform can also be selected by pressing $\frac{1}{175}$ (U-01-U-16), $\frac{1}{276}$ (U-17-U-32), $\frac{1}{377}$ (U-33-U-48) or $\frac{1}{478}$ (U-49-U-64) to select the page, and then pressing the step button.
- The waveform number (U-number) appears on the display.
- The selection range is U-01-U-64.

③ Press $\frac{1}{OK}$ to return to regular mode.



- Press $\frac{1}{CLR/CANCEL}$ to cancel saving.

Step sequencer playback and recording





This section explains step sequence playback and recording.

Pattern playback

- 1 Press .



- Press  again to stop playback.
- At the playback position, the step LED will become lit if unlit or become unlit if lit.
- The page button that corresponds with the current playback position will light red. Other page buttons will be lit green or orange.
- During pattern playback, press a page button to lock the page, lighting it red.

Pressing  (, ,  or ) will unlock the page. (Other page buttons will blink in the same color as when stopped.)

- The page buttons correspond to the steps as follows.

Pattern 1–16 :  lit green

Pattern 17–32 :  lit green

Pattern 33–48 :  lit green

Pattern 49–64 :  lit green

Pattern 65–80 :  lit orange

Pattern 81–96 :  lit orange

Pattern 97–112 :  lit orange

Pattern 113–128 :  lit orange

Selecting patterns





- 1 Press .





- The pattern number is shown.

- 2 Press , , , or  to select the pattern range. (The selected page button will light green/orange.)



- To select pages 5–8, press , , , or  twice. (That page button will light orange.)
- The page buttons correspond to the steps as follows.

Pattern 1–16 :  lit green

Pattern 17–32 :  lit green

Pattern 33–48 :  lit green

Pattern 49–64 :  lit green

Pattern 65–80 :  lit orange

Pattern 81–96 :  lit orange

Pattern 97–112 :  lit orange

Pattern 113–128 :  lit orange

- 3 Press a STEP 1–16 button to select a pattern (and end pattern selection mode).







- The  **VALUE** knob can also be turned to select patterns.



- Selecting the already selected pattern will reload it, clearing the edited settings.

Selecting multiple patterns and playing them back in order (chain playback)

- 1 Press  twice (lights orange).
- 2 Press , , , or  to select the pattern range. (The selected page button will light green/orange.)
- 3 Press step buttons to select patterns in the order to be played.

The step LED for the selected pattern lights and the pattern number is shown on the display.

- 4 Press  to play patterns in the selected order.



- After the last pattern has played, that pattern will continue playing in a loop.

Press  to end chain playback.

- Press the step button for the selected pattern again to deselect it.
- STUTTER mode cannot be used during chain playback.

Initializing patterns

- 1 While pressing , press .



- CLR will appear on the display.
- All note and parameter lock data for the pattern will be cleared.

Step sequencer playback and recording

Step recording

- 1 Press (lights red).

The LED for the current step will blink. The LEDs for steps that already have notes will light.

- 2 Press , , , or to select the page. (The selected page button will light red.)



- The page buttons correspond to the steps as follows.

Steps 1–16 : lit green

Steps 17–32 : lit green

Steps 33–48 : lit green

Steps 49–64 : lit green

Steps 65–80 : lit orange

Steps 81–96 : lit orange

Steps 97–112 : lit orange

Steps 113–128 : lit orange

- Page buttons are enabled or disabled according to the length of the pattern.

- 3 Press the step button for the position to input.

The input note sounds, and the step LED blinks.



- The **VALUE** knob can also be turned to change the step position. (Step notes will sound during movement).

- 4 Play a note on the keyboard.

The note of the key pressed sounds (continuously with sustain).



- Playing the same note that has already been input on the step will clear it.
- To input tied notes, while pressing and holding , press to enable the tie function.
- By pressing a different step button while continuing to hold a keyboard key (changing pages is also possible), a tied note can be added that lasts until that step. (If the same note already exists on the steps of the tied note, it will be overwritten.)
- While pressing and holding , press a step button to delete note and parameter lock data for that step. (If that step includes a tied note, the entire tied note will be deleted. It will not be divided.)
- While pressing and holding , press to turn sequencer auto step on. When this is on, after any keyboard key is released, the sequencer will advance to the next step, and the note on that step will sound.

- When in overwrite mode, playing keyboard keys will overwrite notes on steps. (See “Overwriting steps while recording (overwrite mode)” .)



- Notes cannot be tied from the last page to the first page.
- During tied note input, if a step in a position earlier than the current step is pressed, it will be reversed.
- The button can be used even when not recording.

Recording in real time

- 1 After pressing , press .
- 2 While the pattern is playing back, play the keyboard at the desired input times.



- If a pre-count has been set, playback will start after the pre-count. (The pre-count will be shown on the display.)
- To input tied notes, while pressing and holding , press to enable the tie function.
- When in overwrite mode, playing keyboard keys will overwrite notes on steps. (See “Overwriting steps while recording (overwrite mode)” .)

Directly inputting notes on steps

- 1 Press , , , or to select the page.



- During pattern playback, press a page button to lock to that page. Press to unlock.







- 2 While pressing the step button that you want to input a note on, play the keyboard.







- Notes can also be directly input on steps by pressing step buttons while playing the keyboard.
- Direct input of notes is not possible during real-time recording.
- Direct input of notes cannot be used during STUTTER mode.

Step sequencer playback and recording



Saving patterns

- ① While pressing , press .
- ② Press , ,  or  to select the page.
- ③ Press a step button to select the save destination.



- DONE will appear on the display.
- Press another mode button,  or  to cancel saving the patch memory.
- The  **VALUE** knob can also be turned to select save destination pattern numbers. (Press  to confirm.)





Reloading patterns

- ① Press .
- ② Press  or the step key that corresponds to the current pattern.



- When a pattern is reloaded, the pattern and parameter data are restored to their last saved state.

Recording parameter operations (parameter locking)

- ① Press , ,  or  to select the page.





- During pattern playback, press a page button to lock to that page. Press  to unlock.
- ② Press and hold the button for the step on which you want to change a parameter.
 - ③ Use knobs and buttons to change the parameter.



- Parameter recording data will not be saved if a pattern is not saved after parameters have been recorded.
- No parameters are recorded during STUTTER mode.

Recording parameter operations in real time

- ① While pressing , press  (lights red).
- ② Press  to play the pattern.



- If a pre-count has been set, playback will start after the pre-count. (The pre-count will be shown on the display.)

- ③ Use knobs and buttons to change parameters.



Turning parameter locking on/off

- ① Press .

When  is on, it lights green, and when off, it is unlit.

When on, recorded parameter lock data is applied to change parameters.

Initializing parameter locks

- ① Select the pattern for which you want to initialize parameter locks (see “Selecting patterns”).
- ② Press and hold  (lights red).
- ③ Press .







- When parameter lock data initialization has completed, CLR will be shown on the display.

Clearing note and parameter data

- ① While pressing and holding , press a step to clear its note and parameter data.





-  The LEDs blink for steps on which parameters are recorded.
- When recording notes ( lit red), only notes will be cleared.
- When recording parameters ( lit red), only parameter data will be cleared.
- Normally, when  and  are lit red, note and parameter data will be cleared.

Synchronizing the tempo with an external device connected to the SYNC IN

- ① Connect the LIVEN 8bit warps SYNC IN to the external device SYNC OUT.
- ② Set the clock source to SYNC. (See “Setting the clock source”.)

Step sequencer playback and recording

Synchronizing tempo with an ELZ_1 or Pocket Operator (PO)

- ① Connect the LIVEN 8bit warps headphone out to the ELZ_1 AUX IN or PO input.
- ② While pressing  (lights green), press  **CLOCK**, and select A.OUT.
- ③ Turn the  **VALUE** knob to select ON.



- The synchronization signal is sent from the left channel of the headphone output.
- The right channel of the headphone output outputs a mono mix signal.
- CLOCK menu

SRC	INT	MIDI/SYNC synchronization of external device using LIVEN 8bit warps clock as master (Example 1)
	MIDI	MIDI synchronization using external device clock as master
	SYNC	SYNC synchronization using external device clock as master (Example 2)
	LN.IN	Audio SYNC synchronization using external device (Pocket Operator) clock as master (Example 3) Synchronization signal input on left channel of LIVEN 8bit warps LINE IN, mono signal input on right channel
A.OUT	Turn this on when connecting LIVEN 8bit warps to ELZ_1 or Pocket Operator using Audio SYNC (Example 4)	

Examples of synchronization connections with external devices

Example 1 : LIVEN 8bit warps as master synchronizes external device

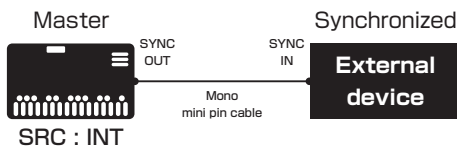

Example 2 : External device as master synchronizes with LIVEN 8bit warps

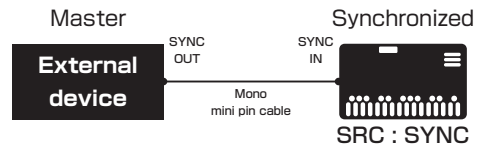

Example 3 : Pocket Operator as master synchronizes LIVEN 8bit warps

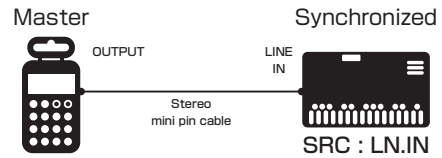



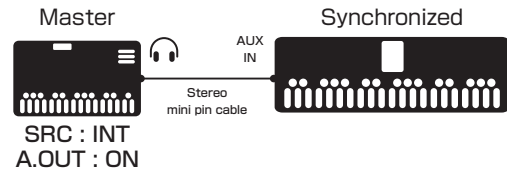

Example 4 : LIVEN 8bit warps as master synchronizes with ELZ_1 or Pocket Operator



Step sequencer and rhythm settings

This section explains settings related to the sequencer and rhythm.



Changing the sequencer mode

- ① While pressing , press , ,  or  to select the sequencer mode (selected sequencer mode lights).



- This mode can be changed even during playback.
- Four types of sequencer mode can be selected.
 1. **NORMAL** (NORM on display) :
 - In this regular mode, steps are played back as they were input.
 2. **SLICE** (SLIC on display) :
 - This mode slices each step to the GATE length.
 - Even tied notes will be played each step.
 3. **RANDOM** (RNDM on display) :
 - Steps are played at random in this mode.
 - All steps will be played.
 - When switching to NORMAL mode, playback will continue after the step that corresponds to the number of steps they have already played in the sequence.
 4. **STUTTER** (STTR on display) :
 - The notes for step buttons that are being pressed will be played in order in this mode.
 - If no step buttons are being pressed, playback will occur as in NORMAL mode.
 - When all step buttons are released, playback will continue after the step that corresponds to the number of steps they have already played.
- Changing or reloading patterns will reset the sequencer mode to NORMAL.

Overwriting steps while recording (overwrite mode)

- ① While pressing , press  (lights red).

Changing the sequencer and arpeggiator gate time



- ① Turn the  **GATE/swing** knob.



- The parameter is shown on the display.
- The adjustment range is 10-90.

- This can be set in a range of 10-90%.
- This setting applies even when the sequencer mode is STUTTER.

Changing the sequencer swing

- ① While pressing , turn the  **GATE/swing** knob.



- The parameter is shown on the display.
- The adjustment range is 0-75.
- This can be set in a range of 0-75%.



Changing the tempo

- ① Turn the  **TEMPO** knob.



- The tempo is shown on the display.
- The adjustment range is 40-250.
- The TEMPO LED blinks in time with the set tempo.
- When the tempo is shown on the display, the  **VALUE** knob can be turned to change it 1 step a time.
- When the tempo is shown on the display, while pressing shift, the VALUE knob can be turned to change it 0.1 step a time.

Changing keys (transposing)

- ① While pressing , press  **TRANSPOSE**.
- ② Turn the  **VALUE** knob to change the key (This raises/lowers the key of the pattern in semitones.)



- The amount of key change is shown on the display.
- The adjustment range is ± 12 (in semitones).
- This is saved in the pattern settings.
- If the key is changed during pattern playback, the actual change of key will occur the next time the pattern begins.



- If transposition causes a note become outside the 0-127 range, it will make no sound.

Step sequencer and rhythm settings

Changing the note of a single step

- ① While pressing , press **NOTE**.
- ② Turn the **VALUE** knob to change the note.



- The note is shown on the display.
- Notes can be set to 1/1, 1/2, 1/4, 1/8., 1/8T, 1/8, 1/16., 1/4T, 1/16, or 1/32. (A . indicates a dotted note, and a T indicates a triplet length.)

Changing the pattern length

- ① While pressing , press **LENGTH**.
- ② Turn the **VALUE** knob to change the length.



- The length is shown on the display.
- The adjustment range is 1-128.

Setting a pre-count

- ① While pressing , press **PRE COUNT**.
- ② Turn the **VALUE** knob to change the pre-count.



- The count number is shown on the display.
- The adjustment range is 0-8.
- The volume of the pre-count is the same as for the metronome. (See "Adjusting the metronome volume" .)

Looper playback and recording

This section explains the 4-track looper that can be used in improvisational performances.

Enabling looper mode

- 1 Press **LOOPER** (lights green).

New recording to looper tracks

- 1 Press $\frac{1}{175}$, $\frac{2}{276}$, $\frac{3}{377}$ or $\frac{4}{478}$ to select a track for recording (page button blink red).



- $\frac{1}{175}$ is track 1, $\frac{2}{276}$ is track 2, $\frac{3}{377}$ is track 3, and $\frac{4}{478}$ is track 4.
- Track 4 is dedicated to external input, and can be used to record the LINE IN input.

- 2 Press **▶** to play the current pattern.



- The remaining number of recording steps will be shown on the display (128-0 steps shown as R128-RO).

- 3 When the count reaches zero, recording will stop and loop playback will start.
The page button for the recorded track lights green.



- After recording completes, the pattern will be muted (**▶** blinks orange). While pressing and holding **shift**, press **▶** to stop muting, or press **▶** to stop the pattern. (Changing the pattern also stop muting.)
- During recording, pressing the page button for the looper track being recorded will cancel recording.
- If the recording time exceeds the maximum amount of time that can be recorded onto a looper track, recording will stop and the recorded data will be discarded. (The display will show FULL.)
- If the tempo is changed after recording, synchronization with pattern playback will not be possible.
- During pattern playback, press the page button to start recording the looper track with the set quantize.

Overwrite recording to looper tracks

- 1 While pressing **▶**, press the page button for a track that has recording data to overwrite it.

Continuous recording to looper tracks

- 1 During recording, pressing a page button that does not have recording data will put the corresponding looper track into recording standby.
- 2 During recording standby, select the next pattern and record new patterns one after the other to different tracks.

Recording without the sequencer

- 1 When the pattern is stopped, pressing a page button while pressing **func** will start recording immediately.



- If multiple track buttons have been pressed, recording standby will be canceled for tracks other than the one being recorded.
- When the pattern is stopped, press the page button to put into recording standby, then play the keyboard to start recording.
- If multiple buttons are pressed, looper tracks are recorded in the order in which they are pressed.

Playing and stopping looper tracks



- 1 Press $\frac{1}{175}$, $\frac{2}{276}$, $\frac{3}{377}$ or $\frac{4}{478}$ to start/stop track playback.
The page button lights green when on and orange when off.







- If a track has no recording data, it cannot be played or stopped.
- Tracks will always play from their beginnings.
- While the sequencer is playing, press the page button to put into playback standby. (Looper plays when the sequencer plays back to the beginning.)
- When playback standby, the page button will blink green.
- When looper tracks are playing back and the pattern is stopped, press **▶** while pressing **func** to put the pattern into playback standby. (The pattern will play when looper tracks returns to the beginning.)

Looper playback and recording

Playing and stopping loopers and patterns at once

- ① During pattern and looper tracks are stopped, press the page button to put looper tracks in standby for playback and then press  to start pattern and looper playback at once.
- ② During pattern or looper track is playing, press  while pressing  to stop pattern and looper playback at once.

Erasing looper tracks

- ① While pressing , press , ,  or  to select the track to erase.

The selected track will be erased, and the page button will become unlit.

Adjusting the looper

This section explains adjustments related to the looper. Explanations assume that looper mode has already been enabled

Adjusting looper track levels

- ① Turn **Main** knobs 1-3.



- The levels are shown on the display.
- The adjustment range is 0-127.
- They can be adjusted from $-\infty$ to +6 dB with 0 dB as the middle values (63-64).
- The **Main** knobs correspond to the tracks as follows.
 - ☉ **Main** knob 1 : Looper track 1
 - ☉ **Main** knob 2 : Looper track 2
 - ☉ **Main** knob 3 : Looper track 3
 - ☉ **Main** knob 4 : Looper track 4
- After recording completes, looper track volume will be reset.

Adjusting the level of looper track 4 and the external input

- ① Turn **Main** knob 4.



- If looper track 4 has recording data, turn **Main** knob 4 to crossfade between looper track 4 and the external input. (Turn **Main** knob 4 all the way to the right to maximize the level of looper track 4 and make the external input level 0. Turn it all the way to the left to minimize the level of looper track 4 and maximize the level of the external input.)
- The moment looper track 4 recording completes, the external input level becomes 0 and looper track 4 level is maximized (as though turned all the way to the right).
- If Looper track 4 has no recording data, the external input level depends on the gain setting value.

Adjusting looper track panning

- ① While pressing **shift**, turn **Main** knobs 1-4.



- The panning is shown on the display.
- The adjustment range is L63-CNTR-R63.
- The **Main** knobs correspond to the tracks as follows.

☉ **Main** knob 1 : Looper track 1

☉ **Main** knob 2 : Looper track 2

☉ **Main** knob 3 : Looper track 3

☉ **Main** knob 4 : Looper track 4

- After recording completes, looper track volume will be reset.

Changing looper quantization

- ① While pressing **func**, press the keyboard **LOOP** key, and select QNTZ.
- ② Turn the **VALUE** knob to change the quantization.



- The quantization is shown on the display.
- The adjustment range is 1-128.

Changing looper length

- ① While pressing **func**, press the keyboard **LOOP** key, and select LEN.
- ② Turn the **VALUE** knob to change the length.





- The length is shown on the display.
- The adjustment range is 1-128.

External input settings

This section explains adjustments related to external input.

Changing the gain

- ① While pressing  (lights green), press  **LINE IN**, and select **GAIN**.
- ② Turn the  **VALUE** knob to change the gain.





- The gain is shown on the display.
- The adjustment range is MUTE-127.
- This can be adjusted from $-\infty$ to +6 dB.



- 90 is 0 dB.

Changing the reverb send amount

- ① While pressing  (lights green), press  **LINE IN**, and select **RVB**.
- ② Turn the  **VALUE** knob to change the send amount.



- The send amount is shown on the display.
- The adjustment range is OFF, 1-127.
- This can be adjusted from $-\infty$ to +6 dB.



- 90 is 0 dB.

Setting mono/stereo

- ① While pressing  , press  **LINE IN**, and select **MONO**.
- ② Turn the  **VALUE** knob to turn it on/off.

MIDI settings

This section explains settings related to MIDI.

Setting the receiving channel

- ① While pressing , press **MIDI**, and select RX.CH.
- ② Turn the **VALUE** knob to change the receiving channel.



- The channel is shown on the display.
- The setting options are ALL, CH.01–CH.16 and NONE.

Setting the transmitting channel

- ① While pressing , press **MIDI**, and select TX.CH.
- ② Turn the **VALUE** knob to change the transmission channel.



- The channel is shown on the display.
- The setting range is CH.01–CH.16.

Turning control change transmission on/off

- ① While pressing , press **MIDI**, and select TX.CC.
- ② Turn the **VALUE** knob to turn it on/off.



- ON/OFF will appear on the display.
- Control change reception is always enabled.

Turning program change transmission on/off

- ① While pressing , press **MIDI**, and select TX.PC.
- ② Turn the **VALUE** knob to turn it on/off.



- ON/OFF will appear on the display.
- Program change reception is always enabled.

Turning MIDI clock output on/off

- ① While pressing , press **MIDI**, and select TX.CK.
- ② Turn the **VALUE** knob to turn it on/off.



- ON/OFF will appear on the display.

Setting MIDI OUT

- ① While pressing , press **MIDI**, and select M.OUT.
- ② Turn the **VALUE** knob, and set MIDI OUT.



- OUT/THRU will appear on the display.

Setting MIDI command

- ① While pressing , press **MIDI**, and select M.CMD.
- ② Turn the **VALUE** knob, and MIDI command.





- Four types of MIDI command settings can be selected.
 - 1.OFF : No receiving or transmitting.
 - 2.RX : Receive only
 - 3.TX : Transmit only
 - 4.RX.TX : Receive and transmit
- Transmit MIDI messages are start and stop.
- Receive MIDI messages are start, continue and stop.

Saving and loading user data

This section explains ways to save and load user data.

User data can be saved and loaded via MIDI. Connect a device that can transmit and receive data by MIDI to the LIVEN 8bit warps.



Exporting patch memories

- ① Select a patch memory you want to export. (See “Changing patch memories and playing.”)
- ② While pressing , press **DATA**.
- ③ Turn the  **VALUE** knob to select MEM.
- ④ Press  to start transmission.



- Regardless of data transmission status,  can be pressed to cancel.
- After transmission completes, DONE will appear on the display and regular mode will resume.
- The data being edited will be exported.



Exporting patterns

- ① Select the pattern you want to export (see “Selecting patterns”).
- ② While pressing , press **DATA**.
Turn the  **VALUE** knob to select PTN.
- ④ Press  to start transmission.



- Regardless of data transmission status,  can be pressed to cancel.
- After transmission completes, DONE will appear on the display and regular mode will resume.
- The data being edited will be exported.

Exporting patch memories and patterns

- ① Select a patch memory you want to export. (See “Changing patch memories and playing.”)
- ② Select the pattern you want to export (see “Selecting patterns”).
- ③ While pressing , press **DATA**.
- ④ Turn the  **VALUE** knob, and select P+M.
- ⑤ Press  to start transmission.



- Regardless of data transmission status,  can be pressed to cancel.
- After transmission completes, DONE will appear on

the display and regular mode will resume.

- The data being edited will be exported.



Importing patch memory and pattern data

- ① Put the unit into regular mode, and start transmitting data from the transmitting device.



- After receiving patch/pattern data completes, this data will be reflected in the current patch/pattern. (It will not be saved.)
- If the received data needs to be saved, save the patch memory or pattern.

Exporting waveform data

- ① Enter waveform editing mode and select the waveform you want to export (see “Editing waveforms (easy mode)” steps ① - ④).
- ② While pressing , press .
- ③ Press  to start transmission.

Importing waveform data



- ① Enter waveform editing mode and select the destination for the imported waveform (see “Editing waveforms (easy mode)” steps ① - ④).
- ② Start transmission on the transmitting device (after receiving completes,  lights green and waveform editing mode is activated).





- After reception completes, the received waveform data will be reflected in the current waveform. (It will not be saved.)
- If the received data needs to be saved, save the waveform.

Saving and loading user data



Backing up user data

- ① While pressing , press the POWER switch to turn on the LIVEN 8bit warps.
- ② Turn the  **VALUE** knob, and select EXPT.
- ③ Press  to start transfer.





- The steps show the progress of data transmission. (The step LEDs will light in order from step 1. Transmission is complete when all step LEDs 1-16 light.)
- Regardless of data transmission status,  can be pressed to cancel.
- After transmission completes, DONE will appear on the display.
- The size of the backup data is 1,487,274 bytes.
- If the size of the data is different, the backup may have failed, so turn the  **VALUE** knob while pressing  to increase the communication interval before step ③. (The default value is 0.)

Restoring user data

- ① While pressing , press the POWER switch to turn on the LIVEN 8bit warps.
- ② Turn the  **VALUE** knob, and select IMPT.
- ③ Press , and start data transmission from the other device.



- The steps show the progress of receiving data. (The step LEDs will light in order from step 1. Receiving is complete when all step LEDs 1-16 light.)
 - Regardless of the data reception status,  can be pressed to cancel. (Received data will be discarded.)
- ④ After receiving completes, SAVE will be shown on the display. Press  to restore the received data.



- After restoring completes, the unit will start normally.

System settings



This section explains settings related to the system.

Explanations assume that the function setting state has been enabled.

Enabling the function setting state

- ① Press and hold .

Setting the automatic power off function

- ① Press , and select A.PWR.
- ② Turn the  **VALUE** knob to select the automatic power off setting.





- Automatic power off has four settings.
 1. OFF : Automatic power off is disabled.
 2. 30 minutes (0.5 on display) : Power will turn off automatically after 30 minutes without operation.
 3. 1 hour (1H on display) : Power will turn off automatically after 1 hour without operation.
 4. 3 hours (3H on display) : Power will turn off automatically after 3 hours without operation.
 5. 6 hours (6H on display) : Power will turn off automatically after 6 hours without operation.



- Unsaved data will be cleared when the power turns off automatically. Always save data that is needed.

Setting the battery type

- ① Press , and select BATT.
- ② Turn the  **VALUE** knob to select the type of battery.





- Two types of batteries can be selected.
 1. Alkaline (ALKL on display)
 2. Nickel-metal hydride (NIMH on display)
 3. Lithium (LTHM on display)
- The remaining charge shown could be higher than the actual amount depending on the type of rechargeable battery.



- Please set this correctly because it effects operation time.



Setting the master tuning

- ① Press , and select TUNE.
- ② Turn the  **VALUE** knob to set the master tuning.



- The master tuning setting (in cents) will be shown on the display.
- The adjustment range is -75 – $+75$.



Setting the clock source

- ① Press , and select SRC.
- ② Turn the  **VALUE** knob to set the clock source.



- The clock source is shown on the display.
- Four types of clock sources can be selected.
 1. INTERNAL (INT on display) : Use LIVEN 8bit warps internal clock
 2. MIDI : Use clock from MIDI
 3. SYNC : Use SYNC IN clock
 4. LINE IN (LN.IN on display) : Use clock from LINE IN



Setting the polarity of SYNC IN

- ① Press , and select S.I.PO.
- ② Turn the  **VALUE** knob to set the clock source.



- The clock source is shown on the display.
- Two types of polarity can be selected.
 1. FALL : Synchronize with the fall of synchronization signal
 2. RISE : Synchronize with the rise of synchronization signal

Setting the polarity of SYNC OUT

- ① Press , and select S.O.PO.
- ② Turn the  **VALUE** knob to set the clock source.



- The clock source is shown on the display.
- Two types of polarity can be selected.
 1. FALL : Synchronize with the fall of synchronization signal
 2. RISE : Synchronize with the rise of synchronization signal

System settings



Setting knob movement function

- ① Press , and select the type of knob movement.



- Two types of knob movement functions can be selected.
- 1. JUMP : When a knob is moved, the parameter changes immediately.
- 2. LATCH (LTCH on screen) : The knob does not affect the parameter value until its position reaches that value. Then, the value follows the knob.



Adjusting the metronome volume

- ① Press , (MTR0 appears on the display.)
- ② Turn the  **VALUE** knob to adjust the metronome volume.





- The metronome volume is shown on the display.
- The adjustment range is 0-15.

Enabling/disabling speaker output

- ① Press  , and select MUTE or SPK.

Setting the headphone gain

- ① Press   **GAIN** to switch between LOUD to SOFT settings.



- The headphone volume is shown on the display.
- Three volume settings can be selected.
- 1. LOUD
- 2. NORM
- 3. SOFT



- Set this correctly to prevent damage to the headphones or external device being used.

Checking the system version



- ① While pressing , press and hold the POWER switch.



- The LIVEN 8bit warps will start up, and VER. will appear on the display.

- ② Press  to select the system version.



- The system version (S X.Y) is shown on the display (X : major version, Y : minor version).
- Press  to check the boot version (B X.Y on display). Press the 2/6 button to check the preset version (P X.Y on display).
- Press the same page button again to show the build number.
- Press  to start up normally.

Restoring to factory default settings (factory reset)

- ① While pressing , press and hold the POWER switch.



- Turn on the LIVEN 8bit warps. F.RST will appear on the display.

- ② Press .



- After resetting completes, DONE will appear on the display.
- Press  to cancel.

Appendix

Figure 1. Sound architecture

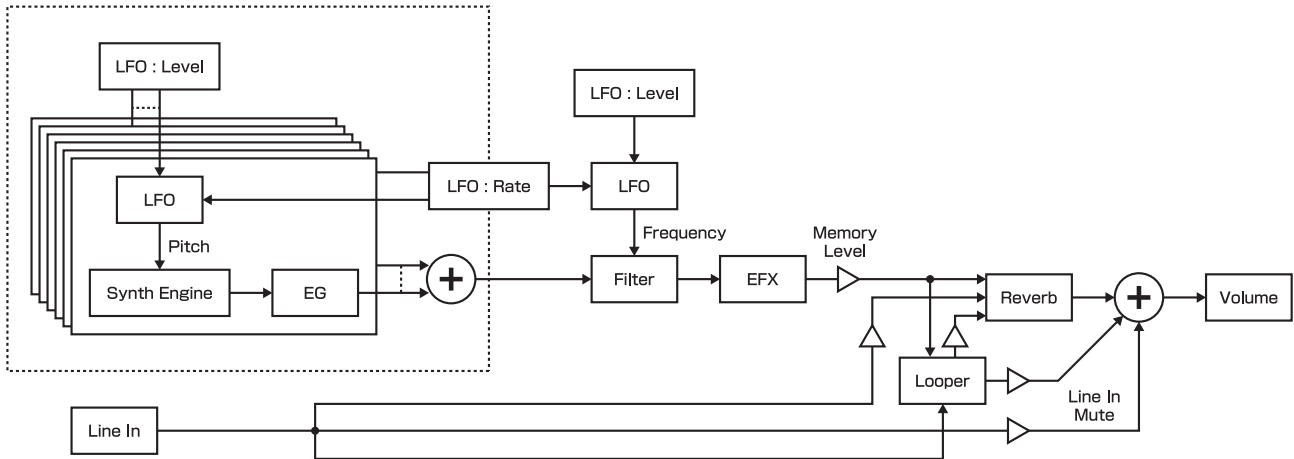

Table 1. Synthesizer engine parameter list

Synth engine	shift button	Main knob 1	Main knob 2	Main knob 3
WARP	OFF	Waveform 1 MEM, preset waveforms 1-63, U-01-U-64 (user waveforms)	Waveform 2 MEM, preset waveforms 1-63, U-01-U-64 (user waveforms)	Crossfade <63 - <00> - 63>
	ON	—	—	—
ATTACK	OFF	Waveform 1 MEM, preset waveforms 1-63, U-01-U-64 (user waveforms)	Waveform 2 MEM, preset waveforms 1-63, U-01-U-64 (user waveforms)	Waveform switching time 0-127
	ON	—	—	—
MORPH	OFF	Waveform 1 MEM, preset waveforms 1-63, U-01-U-64 (user waveforms)	Waveform 2 MEM, preset waveforms 1-63, U-01-U-64 (user waveforms)	Morphing time 0-127
	ON	Waveform 3 MEM, preset waveforms 1-63, U-01-U-64 (user waveforms)	Morphing mode 2 (waveform 1 → waveform 2 → waveform 1 ……), 3 (waveform 1 → waveform 2 → waveform 3 → waveform 1 ……)	—
FM	OFF	Ratio 0.5-32	Level 0-127	LFO rate 0-127
	ON	Ratio depth 0-127	Level depth 0-127	Waveform SINE (sine wave), SQAR (square wave), TRI (triangle wave), SAW (saw wave), R.SAW (reverse saw wave), RAND (random wave), LOG (logarithmic wave), R.LOG (reverse logarithmic wave)